

Ϛ STIGMA

Performing Synthesizer

Version 1.3

© 2017-2023 by Björn Arlt
<http://www.fullbucket.de/music>

Presets and Beta Testing by kraftraum
<https://soundcloud.com/kraftraum>

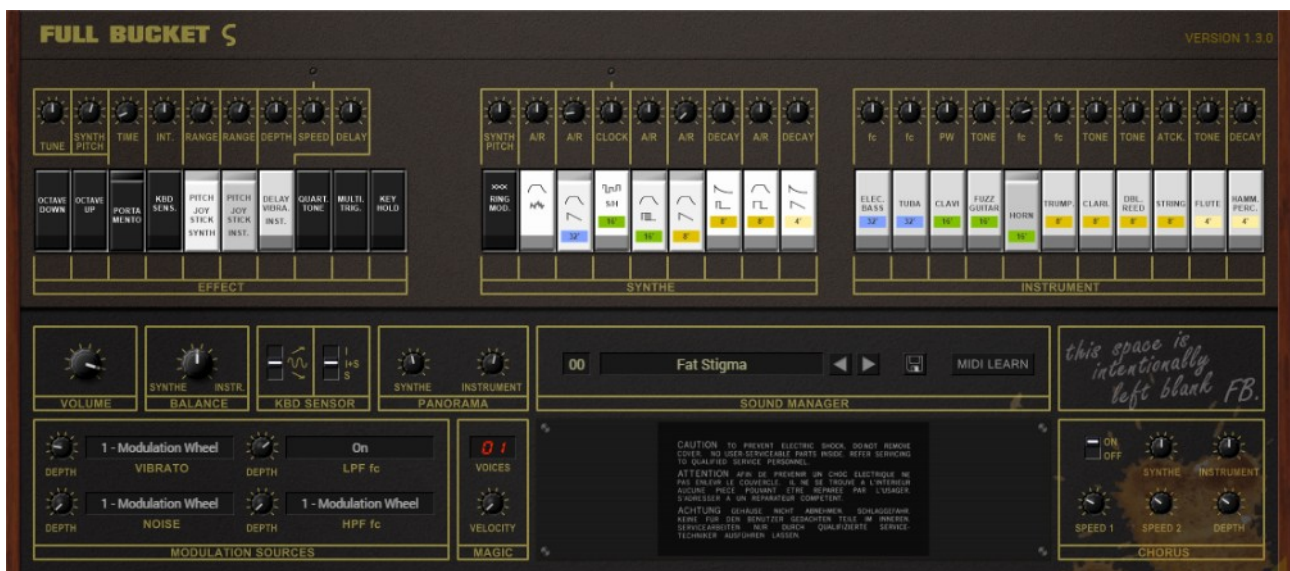

VST is a trademark of Steinberg Media Technologies GmbH
Windows is a registered trademark of Microsoft Corporation
The Audio Units logo is a trademark of Apple Computer, Inc.

Table of Contents

Introduction.....	3
Changes in Version 1.2.....	3
The Stigma Of The <i>Sigma</i>	3
The Truth About The <i>Sigma</i>	4
From The <i>Sigma</i> To The <i>Stigma</i>	5
Acknowledgments.....	6
The <i>Instrument</i> Section.....	7
The <i>Synthe</i> Section.....	8
The <i>Effects</i> Section.....	9
The Control Section.....	10
Volume, Balance, and Panorama.....	10
KBD (Keyboard) Sensor.....	10
From Joystick To Wheels: Modulation Sources....	10
Magic.....	11
The Sound Manager.....	11
MIDI Learn.....	11
File Menu.....	12
Chorus/Ensemble.....	13
The Preset Editor.....	14
The stigma.ini Configuration File.....	15
MIDI Control Change Messages.....	15
Preset Defaults.....	15
Parameters.....	16
Instrument Section.....	16
Synthe Section.....	17
Effects Section.....	18
Chorus/Ensemble.....	18
Control Section.....	19
Preset Editor.....	19
Frequently Asked Questions.....	20

Introduction

The *Stigma* is a software synthesizer plug-in for Microsoft Windows (VST2/VST3) and Apple macOS (VST2/VST3/AU) simulating the KORG® *Sigma KP-30 Performing Synthesizer* from 1979. It is written in native C++ code for high performance and low CPU consumption. The main features are:

- Nineteen *Presets* with individual filters, envelopes, and amplifiers
- Two band-limited oscillators with four footages (32', 16', 8', 4')
- *Synthe* preset section:
 - Eight presets including Noise
 - Individual lowpass and global highpass filters
 - Ring modulator
- *Instrument* preset section:
 - Eleven presets
 - *Delayed Vibrato* effect
- *Effect* section:
 - Portamento, *Quarter Tone*, *Keyboard Sensor* (aftertouch) and more
- Tweaks (not to be found in the original *Sigma*):
 - Up to 64 voices polyphony with Velocity
 - Preset editor
 - Chorus/Ensemble section
- MTS-ESP (<https://oddsound.com/>) dynamic micro-tuning support
- All parameters can be controlled by MIDI controllers
- Plug-in supports Windows (32 bit and 64 bit) and macOS (64 bit)

Changes in Version 1.2

The changes since version 1.1 do not seem to be very impressive:

- Resizable plug-in window
- Added "MIDI Thru" and "Ignore Program Change" options

However, under the hood *Stigma* was ported to the new **iPlug2** framework maintained by **Oli Larkin and the iPlug2 team**. Big thanks, guys!!! Without your work it would not have been possible to create a resizable *Stigma* user interface.

To resize the plug-in you just grab the yellow triangle at the bottom right of the *Stigma* window and drag it. You can save the current window size using the menu entry "Save Window Size" in the *File Menu*.

The Stigma Of The Sigma

Once upon a time I promised myself not to create a simulation of an existing piece of hardware that I do not own by myself. Well, as you can see, I broke my promise *again*: I never owned a *Sigma* nor is it very likely that I ever will. Hey, sounds like the introduction to my *Nabla* string synthesizer! ;-)

In 1979, KORG presented the *Sigma KP-30* "Performing Synthesizer". This monophonic instrument did not sell by far as good as its famous sibling, the *MS-20*, and the main reason was that it was a *Preset Synthesizer*. Now "preset" here meant

something *slightly* different than today's incarnation of this concept: You could not change a bit of the preset settings, it was all carved in stone... sorry, electronics... and there were only 19 (!) presets in total.

The engineers of KORG were well aware of this stigma, and so they added *one* tweakable parameter for each preset plus the option to additively select all 19 presets in every possible combination¹ plus the option to Ring-modulate the 8 *Synthe* presets with the 11 *Instrument* presets.

Having presets is very important if you need to switch instantaneously between two sounds, and so the *Sigma* was the right instrument for many live musicians. But is it a *real* synthesizer or just a *boosted* organ? At least for the hardcore synthesists of the good old analog days the topic was settled... well, look, the *Sigma* has Rocker switches! :-P

The Truth About The *Sigma*

Let's forget all this snobbery and get back to the hard facts: The *Sigma* contains two voltage controlled oscillators (VCOs) that are able to generate sawtooth waves at four different octaves simultaneously (32', 16', 8', and 4'). The first VCO solely feeds the *Instrument* preset section while the second VCOs is used for the *Synthe* section.

A "preset" of the *Sigma* is in fact a full electronic circuitry that processes the output of a VCO at a certain footage. Take the preset "8' Saw" of the *Synthe* (sorry, it is really called like that) section: The input is taken from the 8' sawtooth wave of the second VCO (for some other presets the sawtooth wave is shaped into a pulse wave), filtered by a 2-pole lowpass filter (built around the famous K35 chip known from the *PS* series and early versions of the *MS-10/20*), and shaped by an envelope generator (both cutoff frequency and amplitude). This is the standard subtractive synthesizer architecture! And there are 19 of these (although not all identical nor all equipped with the K35)! Wow!

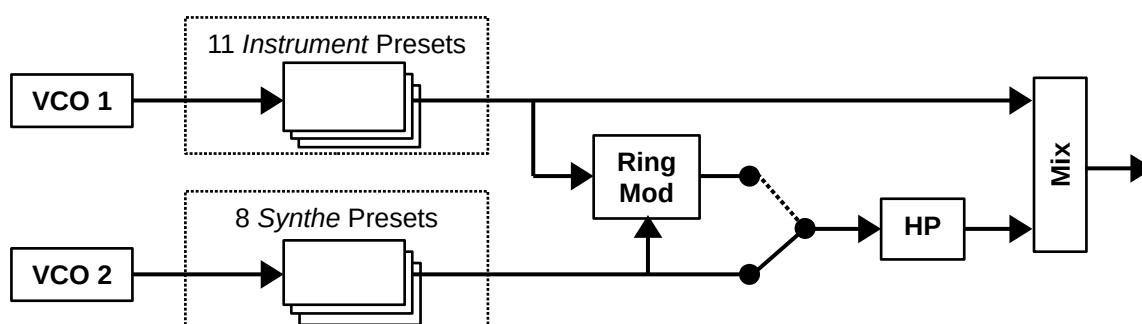

Architecture of one voice of the *Sigma*

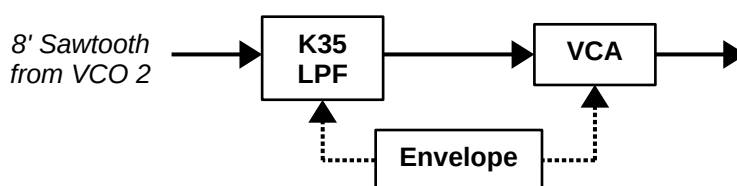

1 Hence the adverted "524287 different tone color variations": $2^{19} = 524288$. Minus 1 for the combination when no preset at all is activated. I <3 marketing.

Typical Preset architecture (here the preset "8' Saw" in the *Synthe* section)

Now if you study the schematics of the *Sigma* you will see that the KORG engineers again did a great job in building clever circuitry with a minimum amount of hardware. In fact the characteristics of the presets are almost completely hard-wired, and altering the parameters of a preset sound would result in exchanging whole parts of the electronics (with a few exceptions). So is the statement that the *Sigma* contains 19 synthesizers in one box true or false?

Definitely true is the fact that there are twelve K35 chips: Eight are built into the eight *Synthe* presets and the rest into four of the *Instrument* presets. Finally, a Ring modulator fed with the outputs of the *Synthe* and *Instrument* sections and followed by a highpass filter (indeed...) can be set to replace the original *Synthe* signal.

Apart from this unconventional architecture, the *Sigma* added some great performance options: Two joysticks to control Pitch Bend/Vibrato and the *Synthe* section's lowpass/highpass filters plus *Keyboard Sensor* (today known as *Aftertouch*) used for pitch modulation, too. There are even more features to be found in the *Effects* section like *Portamento*, *Delayed Vibrato*, *Multiple Trigger*, and *Quarter Tone*. The latter is unique to the *Sigma*: When activated, playing notes *legato* will not result in *chromatic* but in *quarter tone* steps. Rumor says that because of this effect the *Sigma* got rather popular in the Mediterranean and especially the Greek region... ☺

From The *Sigma* To The *Stigma*

It took some time until I convinced myself to create a *Sigma* clone. Concept-wise the *Sigma* is fully in line with everything I love – off-mainstream, unconventional architecture, clever design. But does it make sense to recreate a *Preset* synthesizer? Obviously maybe, and with the *Stigma* I went some new ways:

- First of all the *Stigma* is – optionally – polyphonic. For good reasons I did not add polyphony to the *Mono/Fury* but with the *Stigma* I think it has a real benefit.
- Second, *Velocity* is – optionally – available.
- Third, more sources are available for modulation purposes. For example you can now modulate the lowpass filters of the *Synthe* section by the Vibrato LFO (some users have successfully modified their original *Sigma* this way) or any MIDI CC.
- Fourth, an optional Chorus/Ensemble effect is on board.
- But most important I decided that one should have the possibility to edit the 19 hard-wired presets themselves. Theoretically, this *could* be done with the *Sigma* by exchanging wires, resistors, and capacitors (nah, not really...) but with a plug-in this would be easy! Of course the extent of editing should be limited to what would be technically feasible with the original.

To sum it up: The *Stigma* simulates the *Sigma* but it can be tweaked to do more.

Acknowledgments

kraftraum (<https://soundcloud.com/kraftraum>) has designed 40 of the default patches (#23 "BAS Dub" till #62 "STR String Dark"), but even more I was able to win him for Beta Testing – thank you!!!

And at this point I would also like to say **Thank you!** to all the people who share their information about the *Sigma* via the Internet, especially **Richard Atkinson** and **Lluis Garriga** aka **LOPTUS** for their great demo videos. Furthermore a **BIG THANKS** to **Tim Stinchcombe** and **Will Pirkle** for their in-depth analysis of the K35 filter chip. Last not least another THANK YOU! to the KVR Audio community and to the KORG engineers.

No, I am not affiliated with KORG in what relation ever except that I always find myself entangled with their instruments. ☺

The *Instrument* Section

The *Instrument* section contains 11 presets that can be individually activated by their associated Rocker switches. Each preset has one additional knob that controls one main parameter of the sound. The sources for all *Instrument* presets are the respective footages of VCO 1.

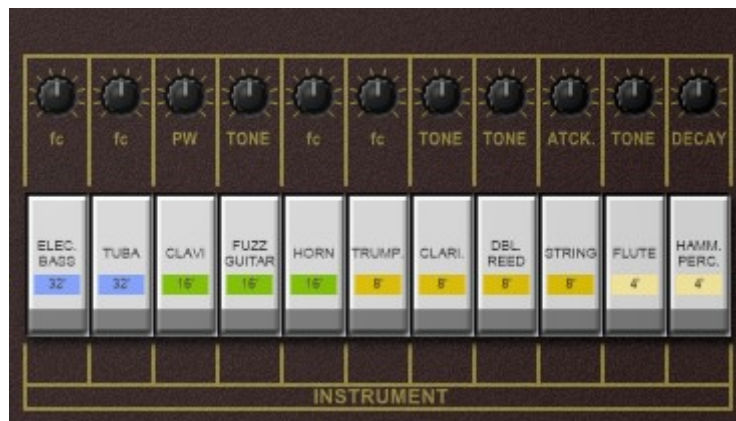

Do I have to mention that the sounds of the presets only remotely resemble the instruments denoted by the preset names? Remember that there are no samples etc. within the *Sigma/Stigma*...

Preset	Base Waveform	Parameter Control
32' Electric Bass	32' Sawtooth	Cutoff frequency of K35 lowpass
32' Tuba	32' Sawtooth	Cutoff frequency of K35 lowpass
16' Clavi	16' Pulse	Pulse Width
16' Fuzz Guitar	16' PWM by Env	Tone (Low / High mix)
16' Horn	16' Sawtooth	Cutoff frequency of K35 lowpass
8' Trumpet	8' Sawtooth	Cutoff frequency of K35 lowpass
8' Clarinet	8' Pulse	Tone (Low / High mix)
8' Double Reed	8' Pulse	Tone (Low / High mix)
8' String	8' Sawtooth	Attack time
4' Flute	4' Sawtooth	Tone (Low / High mix)
4' Hammered Percussion	4' Sawtooth	Decay + Release time

The *Synthe* Section

The *Synthe* section contains 8 presets that can be individually activated by their associated Rocker switches. Each preset has one additional knob that controls one main parameter of the sound. The sources for all *Synthe* presets are the respective footages of VCO 2.

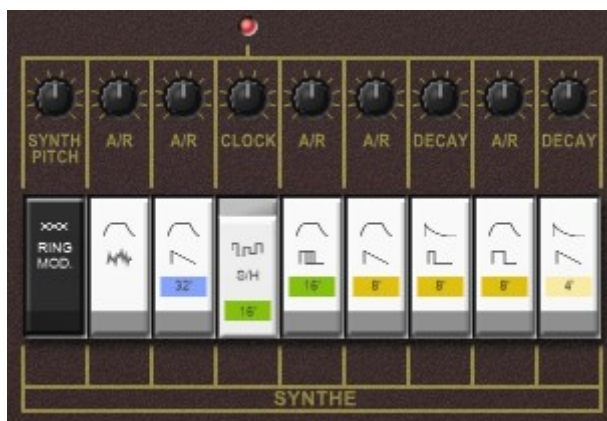

There is also an additional *Ring Modulator* switch that replaces the standard output of the *Synthe* section with the Ring-modulated signal of the *Synthe* and the *Instrument* sections. Note that in order to hear any sound when *Ring Mod* is on, at least one preset of both sections has to be activated.

Along with the *Ring Mod* switch comes a control for (de-)tuning the VCO 2 by ± 7 notes. This pitch control will only be active when *Ring Mod* is activated, too.

Preset	Base Waveform	Parameter Control
<i>Ring Mod</i>	<i>Synthe</i> ⊗ <i>Instrument</i>	<i>Synthe</i> (VCO 2) pitch
<i>Noise</i>	Noise	Attack + Release time
<i>32' Saw</i>	32' Sawtooth	Attack + Release time
<i>16' S/H</i>	16' Sawtooth	Sample & Hold clock rate
<i>16' PWM</i>	16' PWM by LFO	Attack + Release time
<i>8' Saw</i>	8' Sawtooth	Attack + Release time
<i>8' Pulse</i>	8' Pulse	Decay + Release time
<i>8' Rect</i>	8' Rectangle	Attack + Release time
<i>4' Saw</i>	4' Sawtooth	Decay + Release time

The *Effects* Section

The *Effects* section of the *Stigma* does not contain the kind of effects one would expect from a modern synthesizer (i.e. no Chorus, Flanger, Phaser, Delay, Reverb etc.) but some more basic features.

First there are the *Octave Down* and *Octave Up* switches that transpose the whole instrument by one octave up or down. If both switches are activated *Octave Up* wins. Above the two switches are controls for Master Tune and the individual tuning of VCO 2 (± 7 notes). Next comes the *Portamento* Rocker switch with the corresponding *Time* knob; the *KBD Sensor* activates the *Aftertouch* functionality while the *Int.* knob controls the intensity of the effect. For more on this see section *KBD (Keyboard) Sensor*.



Pitch bending and modulation by *Vibrato* or *Noise* (see section *From Joystick To Wheels: Modulation Sources*) can be activated separately for the *Synthe* (VCO 2) and *Instrument* (VCO 1) sections via the *Pitch Joystick* switches; the *Range* knobs control the amount of the modulation effect respectively. The *Delay Vibrato* only applies to the *Instrument* section. Knobs are available for *Vibrato* depth, speed, and delay time.

Quarter Tone is a very unique effect that typically only works in monophonic mode. If it is activated and one plays *legato* notes, the generated note steps are not chromatic but quarter tones. This becomes even more funny when you stop playing *legato* and then press the same key again (since it will now produce the "correct" note).

Multiple Trigger does what one expects it to do (trigger the envelopes even in *legato* mode) and the same is true for *Key Hold* (hold the pressed keys indefinitely).

The Control Section

This section includes all the controls located left of the keyboard of the original *Sigma*: Volume and *KBD Sensor* settings as well as modulation sources (plus some more).

Volume, Balance, and Panorama

Volume sets the total volume of the *Sigma* while *Balance* controls the mix between the *Synthe* and *Instrument* section.



The original *Sigma* has no real stereo output but individual outputs for the *Synthe* and *Instrument* sections respectively. Instead I decided to provide two panorama controls for both sections as done with my *Nabla* synthesizer.

KBD (Keyboard) Sensor

Again a rather unique feature of the *Sigma*: Aftertouch! OK, the ARP *Pro Soloist*, the Teisco *S-100P*, and some others had it too, but it really was something unusual in 1979.

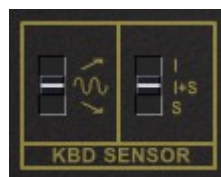

While the intensity of the effect is controlled in the *Effects* section (see above), the destination can be set to *Pitch Bend Up*, *Pitch Bend Down*, or *Vibrato*. Furthermore, one can activate it for the *Instrument* or the *Synthe* section alone or together.

From Joystick To Wheels: Modulation Sources

The original *Sigma* features two (!) *joysticks* for modulation purposes: The horizontal axis of the first joystick directly controls Pitch Bending while the vertical axis controls the amount of modulation of the Vibrato LFO (when pushing the joystick "up") or the *Noise* (when pulling the joystick "down"). In contrast, the horizontal axis of the second joystick is used to control the K35 lowpass filter cutoff frequencies of the eight presets in the *Synthe* section (and only those!) while the vertical axis sets the cutoff frequency of the highpass filter that follows the *Synthe* section.

However, joysticks are pretty out of fashion these days (which is a pity) and to have two of them is pure luxury... thus, with the *Stigma* I had to go a different way to map the joysticks appropriately.



There are four modulation paths available for the *Stigma*: *Vibrato* (Joystick 1 Y axis up; controls the Vibrato modulation depth), *Noise* (Joystick 1 Y axis down; controls the Noise modulation depth), *LPF fc* (Joystick 2 X axis; controls the cutoff of the *Synthe* lowpass filters), and finally *HPF fc* (Joystick 2 Y axis; controls the cutoff of the *Synthe* highpass filter).

For each modulation path the modulation source can be selected from one of the 120 MIDI channel controllers, the output of the Vibrato LFO, the PWM LFO, the S/H LFO, Pitch Bend, or Channel Pressure (Aftertouch). Finally, *Velocity* is also available as a source for *LPF fc*.

Magic

Yes, there is some magic built into the *Stigma*: Polyphony and Velocity. Here you can select the maximum number of voices (1 to 64) plus the amount of effect the Velocity has on the volume of the voice played.



The Sound Manager

But the greatest magic is of course this: A way of storing programs or *patches* and even giving them names! To select one of the 64 patches just click on the program number or the previous/next arrow buttons, and edit its name by clicking in the text field.

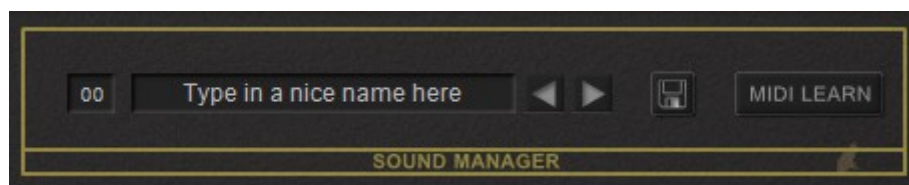

MIDI Learn

Every parameter of the *Stigma* can be controlled by one MIDI controller. If you want to change the assignment of MIDI controller (CC; *MIDI Control Change*) to *Stigma* parameter the *MIDI Learn* function comes in quite handy: Just click the *MIDI Learn* button on the Sound Manager panel (caption turns red) and wiggle both the MIDI controller and the parameter you want to assign (you can abort *MIDI Learn* by clicking the button again). If you want to unlearn the assignment, right-click the *MIDI Learn* button (the label now reads "UNLEARN") and activate it. Now wiggle the MIDI controller or the parameter that you want to unlearn. To save the controller assignments use "Save Configuration" in the *Options* menu (see next section).

File Menu

When clicking on the disk symbol of the *File* button, a context menu opens with the following options:

Copy Program	Copy current program to internal clipboard
Paste Program	Paste internal clipboard to current program
Init Program	Initialize the current program
Load Program	Load a program file containing a patch to the <i>Stigma's</i> current program
Save Program	Save the <i>Stigma's</i> current program to a program file
Load Bank	Load a bank file containing 64 patches into the <i>Stigma</i>
Save Bank	Save the <i>Stigma's</i> 64 patches to a bank file
Select Startup Bank	Select the bank file that should always be loaded when the <i>Stigma</i> is started
Load Startup Bank	Load the Startup bank file; can also be used to check what the current Startup bank is
Unselect Startup Bank	Unselect the current Startup bank
Default Path for Program Files	Sets the default path for program and bank files
MIDI Thru	Set globally if MIDI data sent to <i>Stigma</i> should be sent through to its MIDI output (stored in configuration file)
Ignore Program Change	Set globally if MIDI Program Change data sent to the <i>Stigma</i> should be ignored (stored in configuration file)
Reload Configuration	Reload the <i>Stigma's</i> configuration file; see section <i>The stigma.ini Configuration File</i>
Save Configuration	Save the <i>Stigma's</i> configuration file; see section <i>The stigma.ini Configuration File</i>
Load Preset Defaults	Load the <i>Stigma's</i> Preset defaults from the configuration file; see section <i>The stigma.ini Configuration File</i>
Save Preset Defaults	Save the <i>Stigma's</i> Preset defaults to the configuration file; see section <i>The stigma.ini Configuration File</i>
Save Window Size	Stores the current window size to the configuration file so that it will be restored on the next loading of <i>Stigma</i>
Check Online for Update	When connected to the Internet, this function will check if a newer version of the <i>Stigma</i> is available at fullbucket.de
Visit fullbucket.de	Open fullbucket.de in your standard browser

Chorus/Ensemble

An impressive property of the *Stigma* is that it can easily produce some very thin sounds. To thicken these up there exists an optional Chorus/Ensemble section (not to be found on the *Sigma*). The Dry/wet balance between signal and effect can be set individually for both *Synthe* and *Instrument* as well as the speeds of the two modulation LFOs and the overall modulation depth.



By the way: If you don't like it you don't have to spill coffee over the Chorus. Just switch it off.

The Preset Editor

Alright folks, grab your soldering iron and prepare to modify the very presets of your *Stigma*! It is possible, though cumbersome and error-prone, thus I would recommend to go the easy way and use – ta-da! – the *Stigma Preset Editor*. Just click on the dark plate below the *Sound Manager* and take a look what's inside.



What you see are the eight (in case of "16' PWM" nine) parameters that affect the character of a preset. To select the "right" editor for a preset you can either flip one of the switches above the Preset Editor, activate the preset via its Rocker switch, or push one of the red kick switches that appeared right under the Rocker switches once you "opened" the Preset Editor.

Here is what the Preset Editor can do for you:

- Every preset has the following parameters: *Gain* (preset volume), *Attack*, *Decay*, *Sustain*, and *Release*.
- All the *Synthe* presets plus the *Instrument* presets "32' Electric Bass", "32' Tuba", "16' Horn", and "8' Trumpet" feature a K35 lowpass filter and thus the parameters *Cutoff*, *Resonance*, and *Envelope Modulation*.
- The preset "32' Tuba" is a bit different than the other "K35 presets": Here the envelope signal is routed through a highpass filter before modulating the audio filter. This somehow removes the Sustain part of the envelope, resulting in a AD-like characteristic.
- The remaining *Instrument* presets contain a lowpass and a high/bandpass filter combination. The three parameters control the respective cutoff frequencies and the mix/balance between the two filters.
- The preset "16' PWM" has an additional knob to control the PWM LFO speed.

This might not look very spectacular because I restricted my *Stigma* to what the original *Stigma* would be capable. But remember that there are nineteen of these processing lines available – in parallel!

Of course there is another aspect why I provide the Preset Editor along with the *Stigma*: I do not own a *Stigma* and even from the great video and audio material I studied it is sometimes pretty difficult to find the "right" setting for a preset. Now if you are a fortunate *Stigma* owner and have the feeling that a preset does not sound "right", will you please edit it and maybe even provide it to the community? Great, thanks! You can do this by saving the preset defaults to the *Stigma's* configuration (`stigma.ini`) file; see below.

The stigma.ini Configuration File

The *Stigma* is able to read some settings from a configuration file (`stigma.ini`); the exact location of this file depends on your operating system and will be displayed when you click on "Reload" or "Save Configuration".

MIDI Control Change Messages

All parameters of the *Stigma* can be controlled by MIDI controllers, or more precise: Each MIDI controller (except *Modulation Wheel* and *Sustain Pedal*) can control one of *Stigma's* parameters. The mapping is defined in the `stigma.ini` for example like this:

```
[MIDI Control]
CC5   = 29 # Portamento Time
CC7   = 2  # Volume
CC8   = 4  # Balance
CC10  = 10 # Pan Instrument
...
```

The syntax is straight forward:

```
CC<controller number> = <parameter ID>
```

Given the above example, controller 7 directly controls the overall *Volume* parameter, controller 8 the *Balance* etc. As you can see, comments are introduced by the Pound sign (#); they are here just for description purposes and completely optional.

The *parameter ID* of one of the *Stigma's* parameters is given in the section *Parameters* below. Note that the *controller number* can run from 0 to 119, with the exception of 1 (*Modulation Wheel*) and 64 (*Sustain Pedal*); the latter two are simply ignored. Of course, instead of editing the controller/parameter assignments in `stigma.ini` with a text editor it is much easier to use the *MIDI Learn* function and save the configuration (see section *MIDI Learn* above).

Preset Defaults

As already described in the section *The Preset Editor* the default settings for the 19 presets can be saved and loaded from the configuration file. This provides an easy way of exchanging/restoring the default settings separately from the programs. Note that you still can have *different* preset settings per program!

```
[Preset Defaults]
NOISE P1 Gain=0.500
NOISE P1 Flt1=0.500
NOISE P1 Flt2=0.675
NOISE P1 E>F=0.265
NOISE P1 EnvA=0.500
NOISE P1 EnvD=0.000
NOISE P1 EnvS=1.000
NOISE P1 EnvR=0.505
32' SAW P2 Gain=0.500
...
```

Parameters

Instrument Section

parameter	ID	description
32' ELECTRIC BASS	45	Preset <i>On/Off</i>
	65	Filter cutoff frequency
32' TUBA	46	Preset <i>On/Off</i>
	66	Filter cutoff frequency
16' CLAVI	47	Preset <i>On/Off</i>
	67	Pulse Width
16' FUZZ GUITAR	48	Preset <i>On/Off</i>
	68	Tone control
16' HORN	49	<i>Preset On/Off</i>
	69	Filter cutoff frequency
8' TRUMPET	50	Preset <i>On/Off</i>
	70	Filter cutoff frequency
8' CLARINET	51	Preset <i>On/Off</i>
	71	Tone control
8' DOUBLE REED	52	Preset <i>On/Off</i>
	72	Tone control
8' STRING	53	Preset <i>On/Off</i>
	73	Attack time
4' FLUTE	54	Preset <i>On/Off</i>
	74	Tone control
4' HAMMERED PERC	55	Preset <i>On/Off</i>
	75	Decay + Release time

Synthe Section

parameter	ID	description
RING MOD	36	Ring modulation <i>On/Off</i>
	56	Pitch shift for VCO 2
NOISE	37	Preset <i>On/Off</i>
	57	Attack + Release time
32' SAW	38	Preset <i>On/Off</i>
	58	Attack + Release time
16' S/H	39	Preset <i>On/Off</i>
	59	Sample & Hold clock speed
16' PWM	40	Preset <i>On/Off</i>
	60	Attack + Release time
8' SAW	41	<i>Preset On/Off</i>
	61	Attack + Release time
8' PULSE	42	Preset <i>On/Off</i>
	62	Decay + Release time
8' RECTANGLE	43	Preset <i>On/Off</i>
	63	Attack + Release time
4' SAW	44	Preset <i>On/Off</i>
	64	Decay + Release time

Effects Section

parameter	ID	description
<i>OCTAVE DOWN</i>	19	Transpose one octave down
<i>Master Tune</i>	7	Master tune
<i>OCTAVE UP</i>	20	Transpose one octave up
<i>Synthe Tune</i>	8	Tuning of VCO 2 (<i>Synthe</i> section)
<i>PORTAMENTO</i>	21	Portamento <i>On/Off</i>
	29	Portamento time
<i>KBD SENSOR</i>	22	Keyboard Sensor (Aftertouch) <i>On/Off</i>
	30	Keyboard Sensor (Aftertouch) intensity
<i>PITCH JOYSTICK SYNTHE</i>	23	Pitch modulation of VCO 2 <i>On/Off</i>
	31	Pitch modulation range of VCO 2
<i>PITCH JOYSTICK INSTRUMENT</i>	24	Pitch modulation of VCO 1 <i>On/Off</i>
	32	Pitch modulation range of VCO 1
<i>DELAY VIBRATO INSTRUMENT</i>	25	Delayed Vibrato for VCO 1 <i>On/Off</i>
	33	Delayed Vibrato depth
	34	Delayed Vibrato speed
	35	Delayed Vibrato delay time
<i>QUARTER TONE</i>	26	Quarter Tone effect <i>On/Off</i>
<i>MULTIPLE TRIGGER</i>	27	Multiple Trigger <i>On/Off</i>
<i>KEY HOLD</i>	28	Key Hold <i>On/Off</i>

Chorus/Ensemble

parameter	ID	description
<i>On/Off</i>	76	Switch effect <i>On/Off</i>
<i>Synthe Mix</i>	77	Dry/Wet mix for <i>Synthe</i> section
<i>Instrument Mix</i>	78	Dry/Wet mix for <i>Instrument</i> section
<i>LFO 1 Speed</i>	79	Speed of first modulation LFO
<i>LFO 2 Speed</i>	80	Speed of second modulation LFO
<i>LFO Depth</i>	81	Depth of modulation by the LFOs

Control Section

parameter	ID	description
<i>Volume</i>	2	Master volume
<i>Balance</i>	4	Balance/mix between <i>Synthe</i> and <i>Instrument</i>
<i>KBD Sensor</i>	5	Mode: Pitch Bend up/down or Vibrato
	6	Destination: <i>Synthe</i> , <i>Instrument</i> , or both
<i>Panorama</i>	9	<i>Synthe</i> panorama
	10	<i>Instrument</i> panorama
<i>Vibrato Modulation</i>	11	Modulation control source
	12	Modulation control depth
<i>Noise Modulation</i>	13	Modulation control source
	14	Modulation control depth
<i>LPF fc Modulation</i>	15	Modulation control source
	16	Modulation control depth
<i>HPF fc Modulation</i>	17	Modulation control source
	18	Modulation control depth
<i>Voices</i>	1	Number of voices (1 to 64)
<i>Velocity</i>	3	Velocity depth

Preset Editor

parameter	ID	description
<i>PWM LFO Speed</i>	82	Speed of PWM LFO
<i>Gain</i>	X	Preset volume
<i>Filter Parameter 1</i>	X+1	First filter parameter
<i>Filter Parameter 2</i>	X+2	Second filter parameter
<i>Filter Parameter 3</i>	X+3	Third filter parameter
<i>Attack</i>	X+4	Attack time
<i>Decay</i>	X+5	Decay time
<i>Sustain</i>	X+6	Sustain level
<i>Release</i>	X+7	Release time

Here *X* is the parameter offset for a preset: For the first preset ("Noise") *X* is 83, for the second preset ("32' Saw") *X* is $83 + 1 \times 8 = 91$, for the third preset ("16' S/H") *X* is $83 + 2 \times 8 = 99$ etc.

Frequently Asked Questions

How do I install the Stigma (Windows VST2 32 bit version)?

Just copy the files `stigma.dll` from the ZIP archive you have downloaded to your system's or favorite DAW's VST2 plug-in folder. Your DAW should automatically register the *Stigma* VST2 plug-in the next time you start it.

How do I install the Stigma (Windows VST2 64 bit version)?

Just copy the file `stigma64.dll` from the ZIP archive you have downloaded to your system's or favorite DAW's VST2 plug-in folder. Your DAW should automatically register the *Stigma* VST2 plug-in the next time you start it.

Note: You may have to remove any existing (32 bit) `stigma.dll` from your VST2 plug-in folder or else your DAW may screw the versions up...

How do I install the Stigma (Windows VST3 64 bit version)?

Just copy the files `stigma.vst3` from the ZIP archive you have downloaded to your system's or favorite DAW's VST3 plug-in folder. Your DAW should automatically register the *Stigma* VST3 plug-in the next time you start it.

How do I install the Stigma (Mac VST2/VST3/AU 64 bit)?

Locate the downloaded PKG package file `stigma_1_3_1_mac.pkg` in Finder (!) and do a right- or control-click on it. In the context menu, click on "Open". You will be asked if you really want to install the package because it comes from an "unidentified developer" (me ☺). Click "OK" and follow the installation instructions.

What is the plug-in ID of the Stigma?

The ID is `kp30`.

How can I decrease the Stigma's CPU load?

Whenever it does not degrade the *sound* you need, reduce the number of activated presets.

No Sound When I Activate The Ring Modulator?

Make sure that you have also activated at least one preset of both the *Synthe* and the *Instrument* section.

How do I know if a new version of the Stigma is available?

When connected to the Internet, open the File menu (see section *File Menu*) by clicking the disk icon and select the entry "Check Online for Updates". If a new version of the *Stigma* is available on fullbucket.de the respective information will be shown in a message box.

How Can I Close The Preset Editor Plate?

You have to reassemble the plate; start with the loose hex nut. But put away that screw driver, please.

How do I resize the MPS window?

Just grab the yellow triangle at the bottom right of the *MPS* window and drag it. You can save the current window size using the menu entry "Save Window Size" in the *File Menu*.